

THE SYSTEM IS BASED ON A TILT SWITCH AND MCB SHUNT TRIP.

A TILT SWITCH HOUSED WITHIN THE COLUMN CONTROLS THE SHUNT IN THE IP BOX VIA A LOOPED CIRCUIT.

A VIOLENT IMPACT OR 35 DEGREE INCLINATION OF THE COLUMN WILL CAUSE THE SHUNT TO TRIP THE MCB IN THE IP BOX RESULTING IN ELECTRICAL DISCONNECTION OF **ALL VOLTAGES** TO THE COLUMN.

PHYSICAL DISCONNECTION OF THE PLUG/SOCKET WILL ALSO CAUSE THE SHUNT TO TRIP THE MCB IN THE IP BOX RESULTING IN ELECTRICAL DISCONNECTION OF **ALL VOLTAGES** TO THE COLUMN.

ONCE TRIPPED THE SHUNT AND MCB HAVE TO BE MANUALLY RESET.

THE UNIT IS **NOT** EFFECTED BY INTERRUPTION OF THE INCOMING SUPPLY. THE SYSTEM COMPLIES WITH BS EN 12767:2007

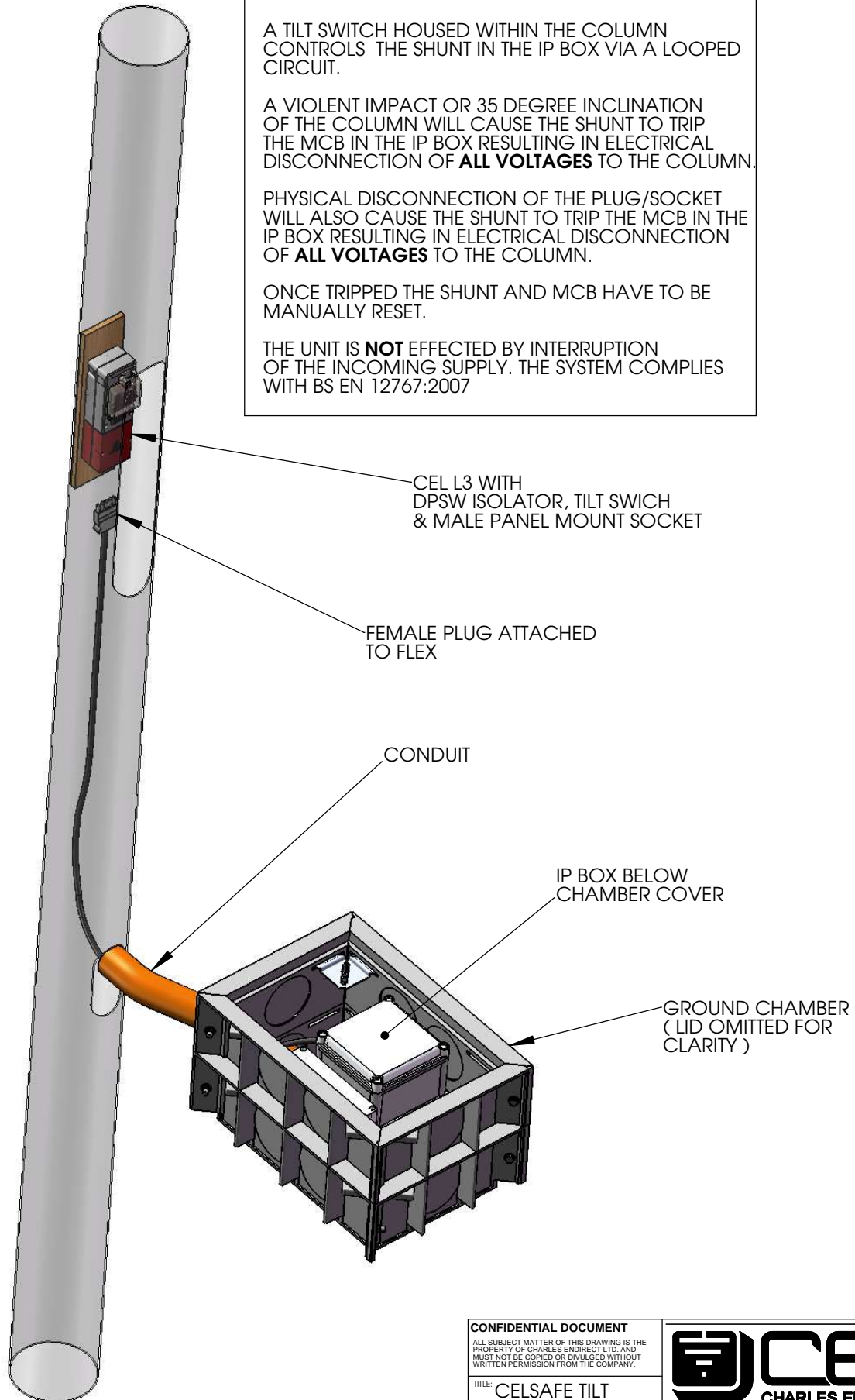

CEL L3 WITH
DPSW ISOLATOR, TILT SWITCH
& MALE PANEL MOUNT SOCKET

FEMALE PLUG ATTACHED
TO FLEX

CONDUIT

IP BOX BELOW
CHAMBER COVER

GROUND CHAMBER
(LID OMITTED FOR
CLARITY)

CONFIDENTIAL DOCUMENT

ALL SUBJECT MATTER OF THIS DRAWING IS THE PROPERTY OF CHARLES ENDIRECT LTD. AND MUST NOT BE COPIED OR DIVULGED WITHOUT WRITTEN PERMISSION FROM THE COMPANY.

TITLE: CELSAFE TILT SYSTEM INFOTECH

CEP 3



Wessex Way, Wincanton, Somerset, BA9 9RR
Tel: 01963 828400 Fax: 01963 828401
Email: info@charlesendirect.com

IF IN DOUBT ASK

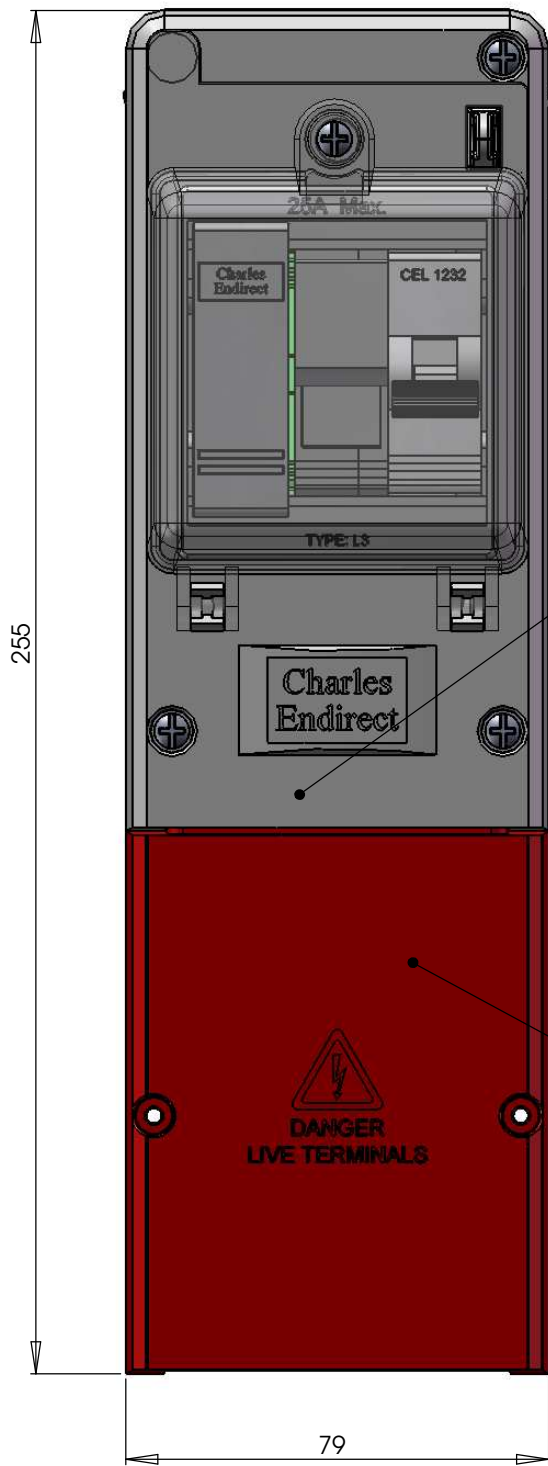

BS88 FUSE CARRIER

EARTH TERMINAL

CEL L3 ISOLATOR

TILT SWITCH

X4 EXTENSION BOX

MALE SOCKET

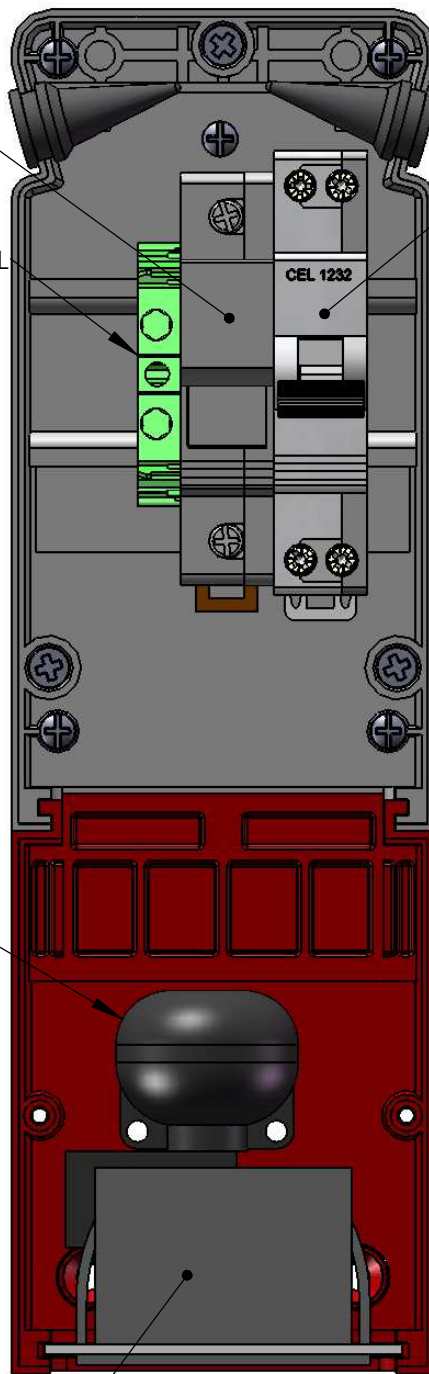

DPSW ISOLATOR

CEL 1232

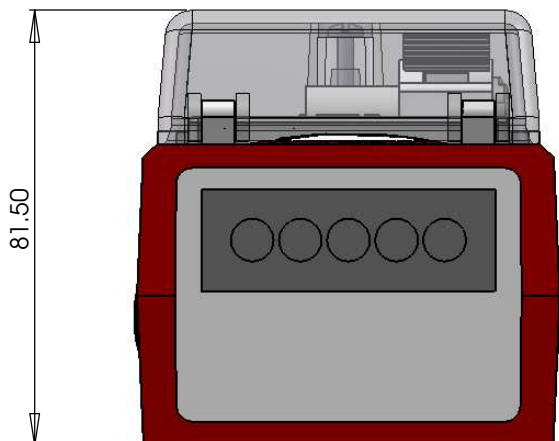

CONFIDENTIAL DOCUMENT
ALL SUBJECT MATTER OF THIS DRAWING IS THE PROPERTY OF CHARLES ENDIRECT LTD. AND MUST NOT BE COPIED OR DIVULGED WITHOUT WRITTEN PERMISSION FROM THE COMPANY.

TITLE: CELSAFE TILT SYSTEM INFOTECH

CEP 3



Wessex Way, Wincanton, Somerset, BA9 9RR
Tel: 01963 828400 Fax: 01963 828401
Email: info@charlesendirect.com

DO NOT SCALE DRAWING

SHEET 2 OF 4

A3

IF IN DOUBT ASK

MANHOLE
RETAINING
PLATE

FLEX TO COLUMN
ISOLATOR

CELSAFE
CHAMBER

TERMINATION IP BOX
HOUSING INCOMING
GLANDS

INCOMING / OUTGOING
CABLES THROUGH BASE
OF IP BOX

GEL COVERING
ALL GLANDS

FREE STANDING
BASE FRAME

PROTECTIVE
DEVICE IP BOX

MCB &
SHUNT TRIP

END STOPS

GROUND CHAMBER & IP BOX

ELEVATED DIN RAIL

GEL COVERING
GLANDS & TERMINATIONS

CONFIDENTIAL DOCUMENT

ALL SUBJECT
MATTER OF THIS
DRAWING IS THE
PROPERTY OF
CHARLES
ENDIRECT LTD.

CELSAFE TILT
SYSTEM
INFOTECH



Wessex Way, Wincanton, Somerset, BA9 9RR
Tel: 01963 828400 Fax: 01963 828401
Email: info@charlesendirect.com

CEP 3

DO NOT SCALE DRAWING

SHEET 3 OF 4

A3

IF IN DOUBT ASK

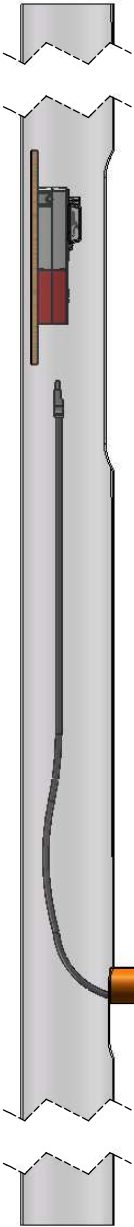
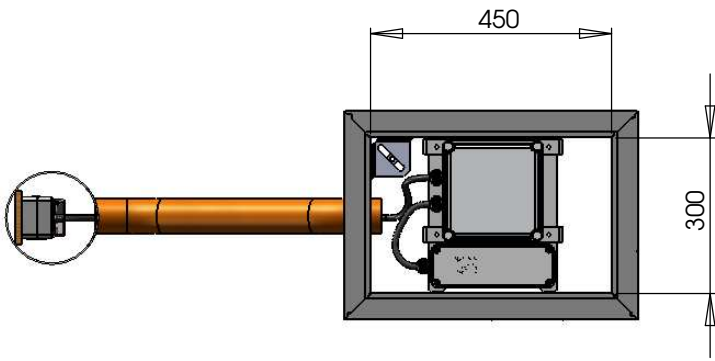

CHAMBER SIDES REMOVED FOR CLARITY

GROUND LEVEL

BASE FRAME LEGS

INCOMING / OUTGOING CABLES

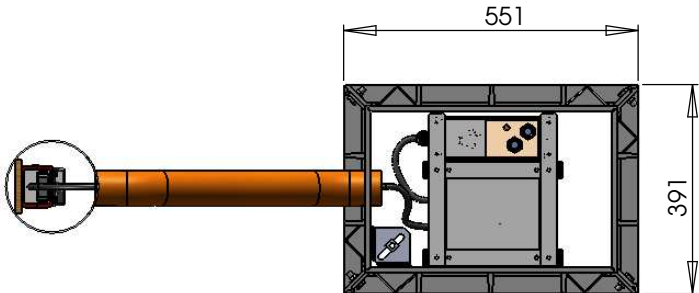
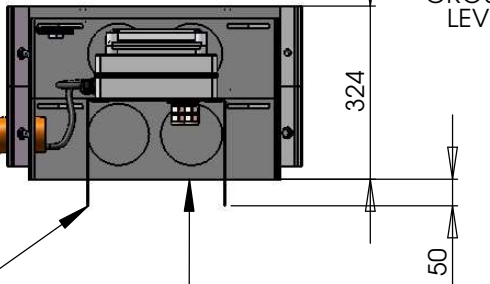

CONFIDENTIAL DOCUMENT
 ALL SUBJECT MATTER OF THIS DRAWING IS THE PROPERTY OF CHARLES ENDIRECT LTD. AND MUST NOT BE COPIED OR DIVULGED WITHOUT WRITTEN PERMISSION FROM THE COMPANY.

TITLE: **CELSAFE TILT SYSTEM INFOTECH**

CEP 3



Wessex Way, Wincanton, Somerset, BA9 9RR
 Tel: 01963 828400 Fax: 01963 828401
 Email: info@charlesendirect.com